

VM15

SINGLE AND DUAL-FUNCTION
SYSTEM FOR GRINDING MACHINE PROCESSES

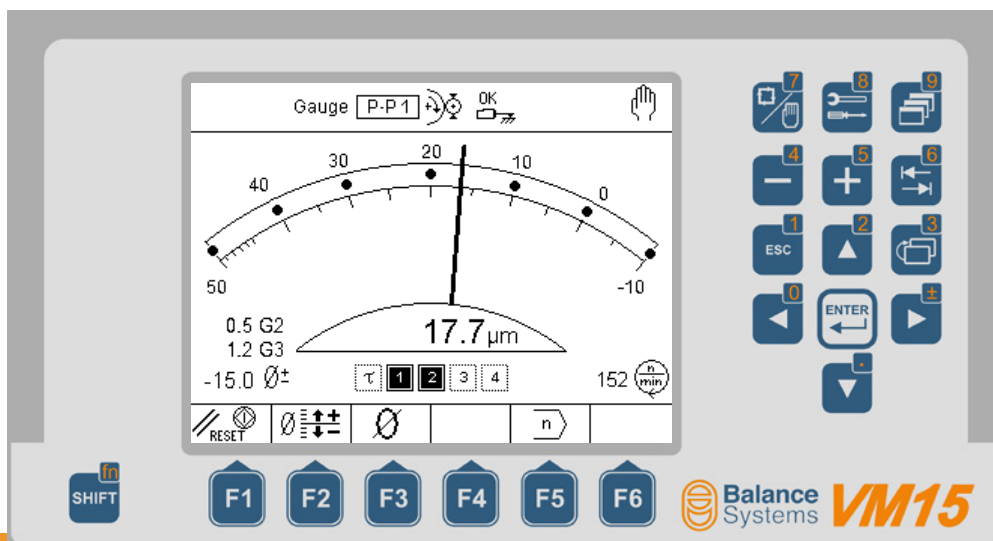

The VM15 is a programmable modular system designed for medium complexity applications in grinding machines, with high performances and cost effective. It is able to provide solutions for:

- Balancing of the grinding spindle on 1 plane
- Touch detection to control the contact grinding wheel-work piece and grinding wheel-dresser, by using acoustic emission and/or power sensors
- In-process gauging (comparative)

Features

- Configuration with control unit in the electrical cabinet and remoted graphic control panel
- User's graphic interface based on ISO symbols
- Each installed function is fully independent. In case that a function is temporarily not available, it can be disabled and the remaining system can continue to operate
- TCP/IP connectivity for service operations and remote diagnostic
- It is provided with the software application "VM15 Service" for backup, restore and software upgrade operations
- A functional upgrade can be made at any time

Benefits

- Ergonomic and easy to setup
- Decisive in optimizing the production process and the quality of the machine
- It is essential in the optimization of the productive process and the machine quality
- Extends lifetime of the machine components (spindle, grinding wheel and dressing tool), reducing the environmental impact
- Does not require surveillance
- Can be integrated in any type of grinding machine, both new and retrofitting

Configuration

The VM15 System is available as:

Single-function

- VM15-B Balancing on 1 plane
- VM15-T Touch detection
- VM15-G In-process gauging

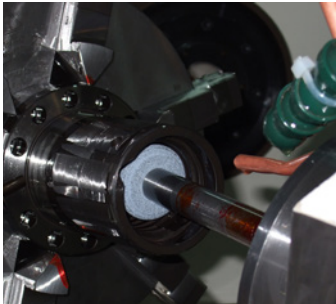

Example: touch detection to centering the grinding wheel

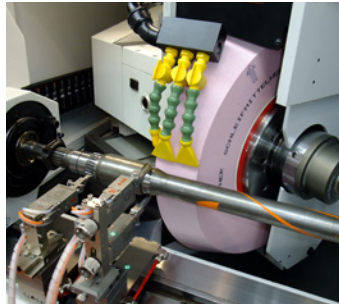

Example: automatic balancing and in-process gauging

Dual-function

- VM15-BT Balancing on 1 plane and touch detector
- VM15-BG Balancing on 1 plane and in-process gauging
- VM15-TG Touch detector and in-process gauging

The typical installation includes

- Control unit with all necessary functions, installed inside the electrical cabinet of the machine. The control unit is directly connected to the PLC/NCU in order to control in real time all the functions
- User remote interface supplied with an independent control panel, with a graphic display and multi-function keyboard with softkey
- Sensors and actuators fitted on the machine in the working area



Balancing function

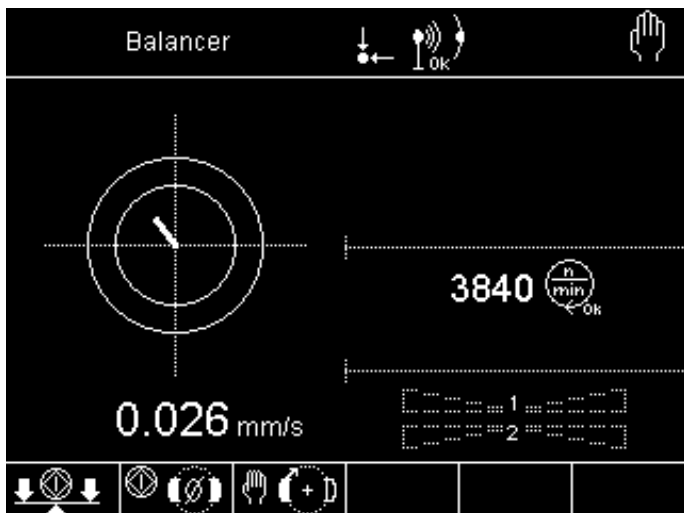

Features

- Automatic balancing on 1 plane with high performances
- Pre-balancing on 1 plane with guided procedure
- Automatic cycle for neutral positioning of the balancing head (weights at 180°)
- Fully controllable by PLC

Benefits

- Essential to optimize the surface finish quality
- Constantly controls the spindle vibrations with status and warning signalling
- Extends lifetime of the spindle, grinding wheel and dressing tool, reducing the environmental impact
- It can be integrated in any high speed process

Compatible balancing heads

SDx balancing heads are the first devices in the world which have been specifically designed by Balance Systems with moment-free architecture. This solution gives the benefit of no dynamic-influence on the grinding spindle which improves the surface finishing. All the balancing heads can be controlled both via cable and contact less (NoLink). An acoustic emission sensor (AE) can be embedded in order to implement the touch detection control (optional).

- Complete SDE range of balancing heads for external mounting with flange. It is suitable for retrofitting application

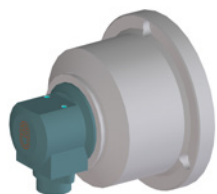

Fitting diameter [mm]	Max compensation capacity [gcm]
95	1700
114	6500
130	12000

- Complete SDI range balancing of heads for built-in spindle assembly by flange or by self-lock system

Diameter of the spindle bore [mm]	Max compensation capacity [gcm]
38	580
42	1200
50	2000
55	4400
60	5000
63, 70, 81	8700

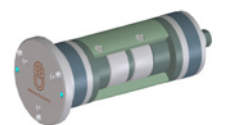

SDI for flange assembly

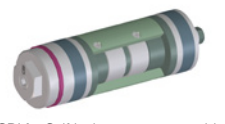

SDI for Self-lock systems assembly

Customized solutions with different dimensions and capacities are available upon request.



Touch Detector function

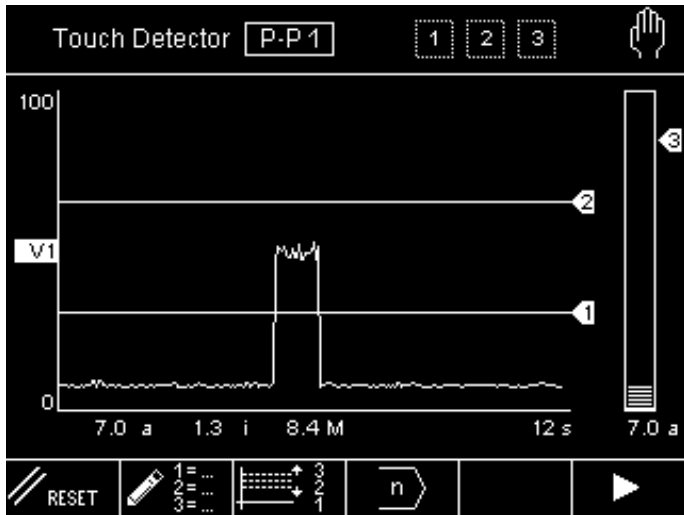







Features

- Up to 2 channels for acoustic emission (AE) sensor
- 1 channel for power transducer
- Up to 4 part program to control the touching conditions (e.g. grinding wheel-work piece and grinding wheel-dresser)
- Setup based on frequency analysis

Benefits

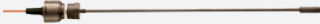
- Essential to reduce cycle times
- Gives a perfect control of the shape of the tools (e.g. the grinding wheel profile)
- Improves safety and reduces maintenance costs
- Extends lifetime of the tools (i.e. grinding wheel, dressing unit)

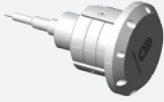
Compatible acoustic emission sensors (AE)

Type	Mounting
 AE Ultrasonic	Static (machine table, work head body, tailstock body, dresser body, spindle body, etc.)
 AE Single Point	Static (machine table, work head body, tailstock body, dresser body, spindle body, etc.)
 AE nose (contact less)	Spindle nose (OD and ID grinding spindle, dressing spindle, etc.)
 AE Built-in (contact less)	Built-in spindle (OD and ID grinding spindle, dressing spindle, etc.)
 AE Ring (contact less)	Outside coaxial device to rotor (OD and ID grinding spindle, dressing spindle, work head, tailstock, etc.)
 AE Embedded (contact less)	Embedded into the body of the balancing head (grinding spindle external or internal side)
 AE Fluid	Static and crossed by coolant (grinding area, dressing area, etc.)

Customized solutions with different dimensions and shapes are available upon request.

Power transducer

Type	Mounting
 Power transducer	Installed in the machine cabinet. It is connected between the drive and the motor of the spindle to be monitored. The digital value of the instantaneous power is transferred to the VM15 control unit by optical fiber.





In-Process Gauge function

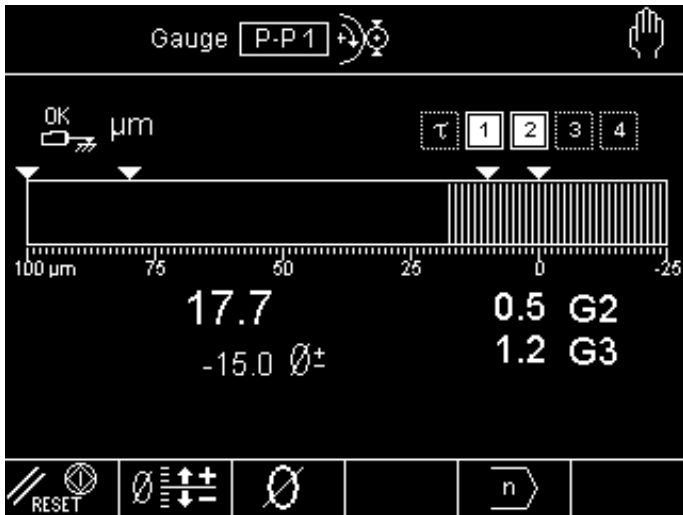

Features

- Up to three channels for gauging heads (e.g.: one diameter and one axial positioning device with binary interface or BCD) “plug & play”
- Up to 3 channels for gauge heads “plug & play” (e.g.: 1 diameter and 1 passive axial positioning with binary interface or BCD simultaneously)
- 8 part-programs (external diameter, internal diameter, thickness, taper, active and passive positioning, etc.)
- Measurement of smooth or interrupted surfaces
- 4 commands to control the feed rate (roughing, finishing, dwell, end of cycle)
- Anti-crash solutions
- Process diagnostics

Benefits

- Makes production stable and consistent with tight tolerances
- Compensates for the grinding wheel wear
- Can be implemented in any type of grinding machine, both new and retrofitting
- Easy to use
- Does not require surveillance
- It reduces down times in case of accidental damages to the equipment

Range of gauge heads and accessories

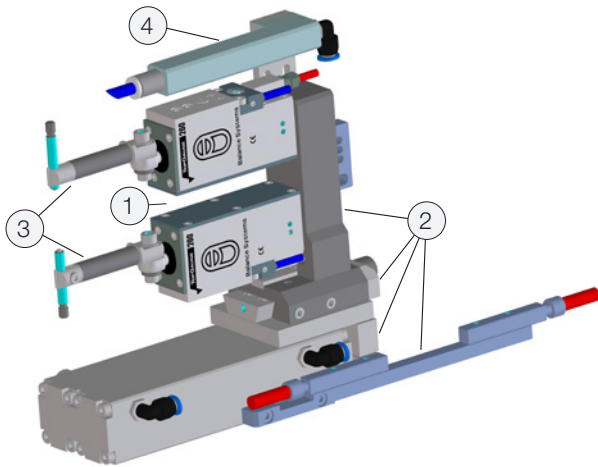

ID	Type	Description
1	Top Gauge 200	Modular gauge head TG200: <ul style="list-style-type: none"> • TxN – universal small range, w/o retraction • TxF – universal small range, with retraction • TxR – universal small range, with adjustable retraction
2	Supports and glides	<ul style="list-style-type: none"> • Complete set of fixed and re-toolable brackets • Pneumatic and hydraulic slides with stroke of 50mm, 75mm, 100mm, 144mm
3	Brackets and probes	<ul style="list-style-type: none"> • Complete set of fingers with different shape and length, fixed or re-toolable, with anti-crash option (exclusive Balance Systems's design) • Threaded contact in chemical diamond or carbide • Roll bar contact in carbide
4	Thermal stabilization	Kit of systems for thermal stabilization based on “showers” of coolant liquid

All the solutions are professionally designed and customized according to the range of measurement, the center height and the type of surface to be measured.



Specifications may be subject to change without notice. © 2015 | 09 | Balance Systems S.r.l.

Distributor:

Balance Systems S.r.l
 Via Roberto Ruffilli, 8/10
 20060 Pessano con Bornago
 (Milan) - Italy
 Tel. (+39) 02.9504955
 Fax (+39) 02.9504977
 info@balancesystems.it
 www.balancesystems.com

